

POMPE CENTRIFUGHE MONOGIRANTI

SINGLE-STAGE CENTRIFUGAL PUMPS

SERIE C



 Pompe centrifughe per la distribuzione d'acqua negli impianti domestici e per le piccole irrigazioni. Aspirazione fino a 3 metri.

Corpo pompa in ghisa. Girante in noryl nei modelli fino a 1 HP; in ottone per potenze superiori. Tenuta meccanica in ceramica/grafite. Motore chiuso autoventilato. Albero in acciaio inox AISI 416.

Tensione monofase con protezione termica incorporata; tensione trifase con protezione a cura dell'utente.

Protezione IP 44. Isolamento classe F. Temperatura massima dell'acqua da pompare 50 °C per i modelli fino ad 1HP; 70 °C per i modelli superiori.

 Centrifugal pumps suitable for the raising and the distribution of water in domestic plants and for a lot of jobs around the house and farm. Suction head up to 3 metres depth.

Pump body in cast iron. Impeller in noryl on models up to 0.75kW; in brass on other models. Mechanical seal in ceramic/carbon. Closed self-ventilated motor. Shaft in stainless steel AISI 416.

Single-phase voltage with built-in motor protector. The three-phase pump must be protected by a fused remote isolator switch.

Protection class IP 44. Insulation class F. Max. temperature of pumped water 122 °F (50 °C) for models up to 0.75kW, 158 °F (70 °C) for bigger models.

 Pompes centrifuges indiquées pour la distribution d'eau dans les installations domestiques et pour plusieurs d'autres emplois autour des maisons, chalets et fermes. Aspiration jusqu'à 3 mètres de profondeur.

Corps de pompe en fonte. Roue en noryl sur les modèles jusqu'à 1 CV; en laiton sur les autres modèles. Garniture mécanique en céramique/graphite. Moteur enfermé avec ventilation extérieure. Arbre en acier inox AISI 416.

Bobinage monophasé avec protection thermique incorporée; bobinage triphasé avec protection par l'utilisateur.

Protection IP 44. Isolation classe F. Température max. de l'eau pompée 50 °C dans les modèles jusqu'à 1CV, 70 °C dans les autres modèles.

 Kreiselpumpen zur Hauswasserversorgung und für Bewässerungsanlagen. Manometrische Saughöhe bis zu 3 Meter.

Pumpengehäuse aus Grauguß. Laufrad aus Noryl bei Pumpen bis zu einer Leistung von 1 HP; aus Messing bei Pumpen mit höherer Leistung. Keramik/Graphit Gleitringdichtung. Antriebswelle aus rostfreiem Stahl AISI 416.

Einphasenspannung mit thermischen Motorschutz; Dreiphasenspannung mit Motorvollschutz nach Benutzersorge.

IP 44 Schutz. Isol. Klasse F. Max. Temperatur der Flüssigkeit: 50 °C bei den Modellen bis zu 1HP, 70 °C bei allen anderen Modellen.

Modello Model Modèle Modell	Potenza Power Puissance Pferdestärke		Tensione Voltage Bobinaje Spannung V-Hz-ph	A	Portata - Capacity - Débit - Fördermenge (l/min)											
	HP	kW			0	20	40	80	120	160	200	240	280			
	Prevalenza - Head - Hauteur - Förderhöhe (m)															
C 50	0,5	0,37	230-50-1	3,0	24	22	20	10								
			230/400-50-3	1,8/1,0												
C 75	0,75	0,55	230-50-1	4,5	29	27	25	16								
			230/400-50-3	2,6/1,5												
C 100	1	0,75	230-50-1	5,2	32	31	29	22								
			230/400-50-3	3,2/1,8												
C 150	1,5	1,1	230-50-1	8,9	40	39	37	33	27							
			230/400-50-3	4,8/3,0												
C 200	2	1,5	230-50-1	11,9	48	47	45	42	35							
			230/400-50-3	6,4/3,8												
C 300	3	2,2	230/400-50-3	9,2/5,2	55	54	51	46	40							
C 400	4	3	230/400-50-3	14,0/8,0	47	46	46	45	44	43	41	39	35			
C 550	5,5	4	230/400-50-3	17,0/10,0	57	56	56	56	55	54	53	50	48			

*On request other voltages are available

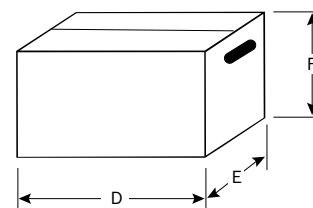
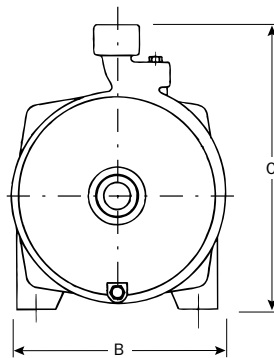
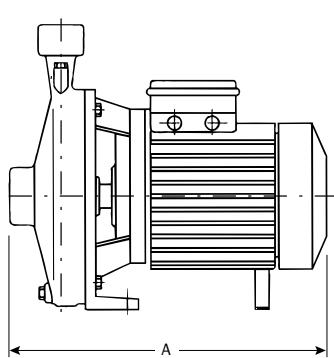
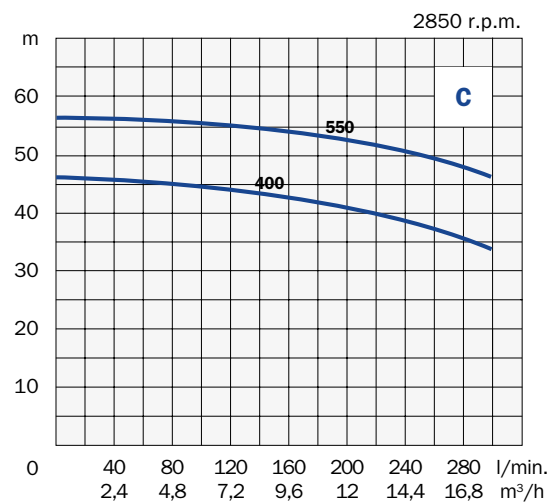
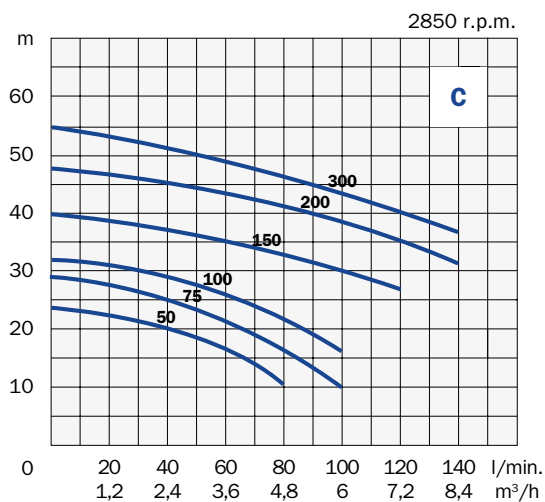

Modello Model Modèle Modell	Aspirazione Suction Aspiration Saug-Seite	Mandata Discharge Refoulement Druck-Seite	Dimensioni - Dimensions - Masstabelle						Peso Weight Poids Gewicht kg
			mm						
			A	B	C	D	E	F	
C 50	1" - DN 25	1" - DN 25	265	175	230	290	190	250	9
C 75	1" - DN 25	1" - DN 25	315	180	250	320	210	270	13
C 100	1" - DN 25	1" - DN 25	315	180	250	320	210	270	14
C 150	1"1/4 - DN 32	1" - DN 25	360	230	300	385	235	320	20
C 200	1"1/4 - DN 32	1" - DN 25	360	230	300	385	235	320	24
C 300	1"1/4 - DN 32	1" - DN 25	360	230	300	385	235	320	25
C 400	2" - DN 50	1"1/4 - DN 32	450	250	320	470	285	355	36
C 550	2" - DN 50	1"1/4 - DN 32	450	250	320	470	285	355	38