

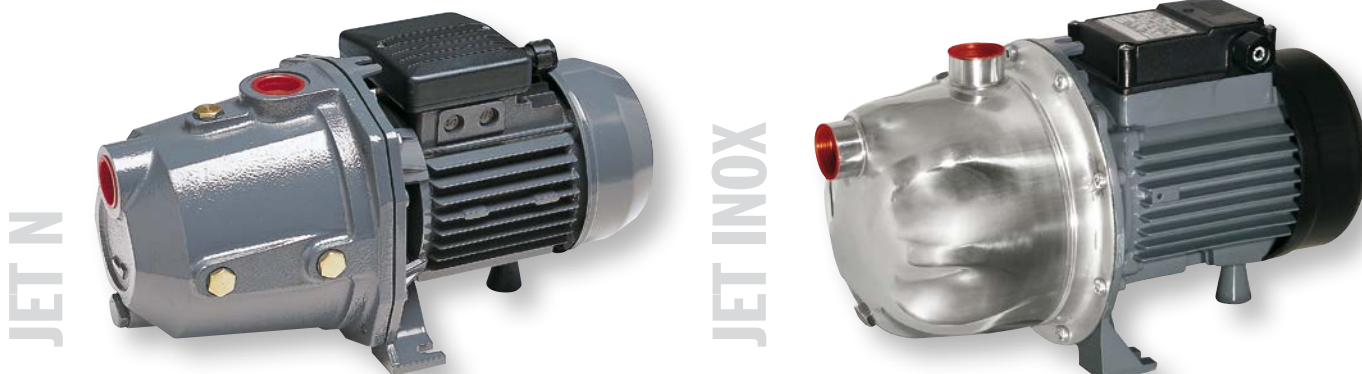

# POMPE AUTOADESCANTI

## SELF-PRIMING PUMPS



 Pompe autoadescenti ideali per impianti domestici e per irrigazione di orti e giardini. Particolarmente indicate per autoclavi.

Alto rendimento. Aspirazione fino a 9 metri.

Corpo pompa in ghisa sui modelli JET 80 N – 100 N; in acciaio inox AISI 304 sui modelli JET 80 INOX – 100 INOX. Girante in noryl. Tenuta meccanica in ceramica/grafite. Motore chiuso autoventilato. Albero in acciaio inox. Tensione monofase con protezione termica incorporata.

Protezione IP 44. Isolamento classe F. Temperatura massima dell'acqua da pompare: 50 °C per la serie JET N, 35 °C per la serie JET INOX.

 Self-priming pumps suitable for the raising and the distribution of water in domestic plants and for small irrigation systems.

They are also recommended for pressure systems. High performance. Suction head up to 9 metres depth.

Pump body in cast iron on models JET 80 N – 100 N; in stainless steel AISI 304 on models JET 80 INOX – 100 INOX. Impeller in noryl. Mechanical seal in ceramic/carbon. Closed self-ventilated motor. Shaft in stainless steel.

Single-phase voltage with built-in motor protector.

Protection class IP 44. Insulation class F. Max. temperature of pumped water: 122 °F (50 °C) for series JET N, 95 °F (35 °C) for series JET INOX.

 Pompes autoamorçantes indiquées pour la distribution d'eau dans les installations domestiques et pour de petites irrigations.

Particulièrement indiquées pour groupes surpresseurs. Rendement élevé. Sécurité de fonctionnement. Aspiration jusqu'à 9 mètres de profondeur.

Corps de pompe en fonte sur les modèles JET 80 N – 100 N; en acier inox AISI 304 sur les modèles JET 80 INOX – 100 INOX. Roue en noryl. Garniture mécanique en céramique/graphite. Moteur enfermé avec ventilation extérieure. Arbre en acier inox.

Bobinage monophasé avec protection thermique incorporée. Protection IP 44. Isolation classe F. Température max. de l'eau pompée: 50 °C pour la série JET N, 35 °C pour la série JET INOX.

 Selbstansaugende Pumpen zur Hauswasserversorgung, zur Bewässerung usw. Hohe Förderleistung. Sicher im Betrieb. Manometrische Saughöhe: 9 Meter.

Pumpengehäuse aus Grauguß bei den Modellen JET 80 N – 100 N; aus rostfreiem Stahl AISI 304 bei den Modellen JET 80 INOX – 100 INOX. Laufrad aus Noryl. Keramik/Graphit Gleitringdichtung. Antriebswelle aus rostfreiem Stahl.

Einphasenspannung mit thermischen Motorschutz. IP 44 Schutz. Isol. Klasse F. Max. Temperatur der Flüssigkeit: 50 °C bei den Modellen JET N, 35 °C bei den Modellen JET INOX.

Modello Model Modèle Modell	Potenza Power Puissance Pferdestärke		Tensione Voltage Bobinage Spannung V-Hz-ph	A	Portata - Capacity - Débit - Fördermenge (l/min)						
	HP	kW			0	10	20	30	40	50	60
	Prevalenza - Head - Hauteur - Förderhöhe (m)										
<b>JET 80 N</b>	0,8	0,59	230-50-1	2,9	40	35	29	21	12		
<b>JET 100 N</b>	1	0,75	230-50-1	4,7	48	45	41	36	29	21	11
<b>JET 80 INOX</b>	0,8	0,59	230-50-1	3,8	42	37	29	21	10		
<b>JET 100 INOX</b>	1	0,75	230-50-1	4,8	51	45	37	28	19	7	

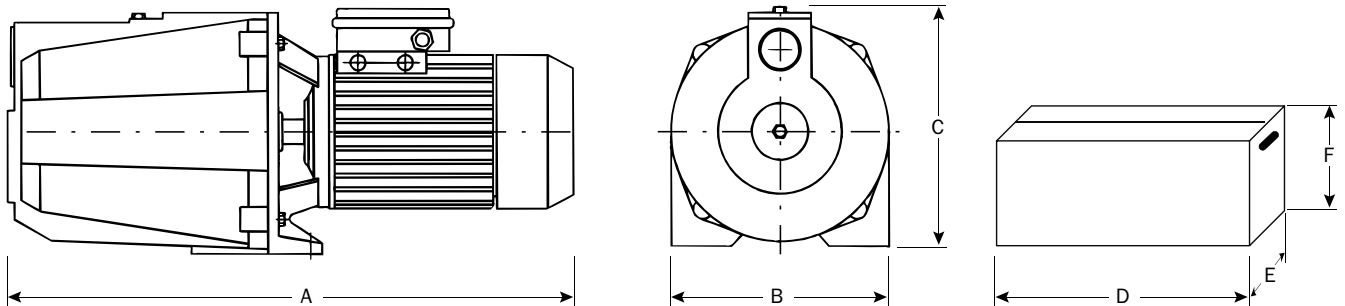
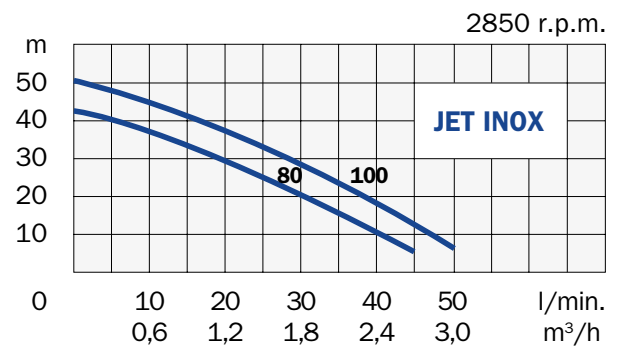
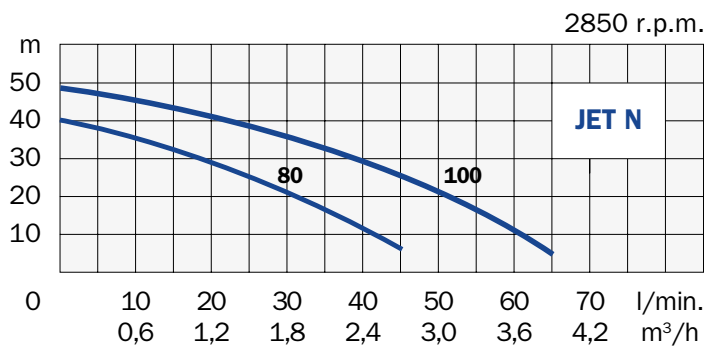

Modello Model Modèle Modell	Aspirazione Suction Aspiration Saug-Seite	Mandata Discharge Refoulement Druck-Seite	Dimensioni - Dimensions - Masstabelle						Peso Weight Poids Gewicht kg
			mm						
			A	B	C	D	E	F	
<b>JET 80 N</b>	1" - DN 25	1" - DN 25	366	190	210	410	200	220	10
<b>JET 100 N</b>	1" - DN 25	1" - DN 25	390	190	210	410	200	220	12
<b>JET 80 INOX</b>	1" - DN 25	1" - DN 25	366	200	220	375	210	250	7
<b>JET 100 INOX</b>	1" - DN 25	1" - DN 25	366	200	220	375	210	250	9