

POMPE SOMMERGIBILI PER LIQUAMI - DN 150

SUBMERSIBLE PUMPS FOR SEWAGE WATER - DN 150

VORTEX 1000 - 6800





PIEDE DI ACCOPPIAMENTO
AUTOMATIC COUPLING FOOT



 Pompe sommergibili adatte alla movimentazione di acque sporche e rifiuti industriali contenenti corpi solidi o filamentosi, fognature urbane e liquami di stalla. Motore 4 poli. Robusta costruzione. Coperchio, cassa statore e corpo mandata in ghisa. Girante monocanale in ghisa. Albero in acciaio inox AISI 420. Doppia tenuta meccanica in camera d'olio: entrambe le tenute sono in carburo di silicio. Cavo di alimentazione di 10 metri in neoprene H07RN8-F tensione trifase 400/690V. Protezione a cura dell'utente. Protezione IP 68. Isolamento classe F. Temperatura massima del liquido da pompare 40 °C; pH: 6 – 10; massima densità 1100 kg/m³.

 Submersible pumps suitable for the pumping of sewage effluents containing solid or fibrous parts in industrial, agricultural and domestic waste water plants. 4 poles motor. Heavy duty construction. Pump housing and impeller in cast-iron. Single channel impeller. Shaft in stainless steel AISI 420. Double mechanical seal in oil chamber: both the mechanical seals are in silicon carbide. 10 metres supply cable H07RN8-F three-phase voltage 400/690V. The pumps must be protected by a fused remote isolator switch. Protection class IP 68. Insulation class F. Max. temperature of pumped liquid 104 °F (40 °C); pH: 6 – 10; max. density 1100 kg/m³.

 Pompes submersibles indiquées pour eaux chargées avec corps solides ou fibreux. Particulièrement conseillées pour eaux résiduaires, pour traitement des eaux industrielles et pour d'autres emplois dans le domaine agricole et zootechnique. Moteur 4 pôles. Construction robuste. Couvercle, corps de pompe et corps de refoulement en fonte. Roue monocanal en fonte. Arbre en acier inox AISI 420. Double garniture mécanique en chambre d'huile: toutes les deux garnitures mécaniques sont en carbure de silicium. Câble électrique H07RN8-F de 10 mètres bobinage triphasé 400/690V. Protection par l'utilisateur. Protection IP 68. Isolation classe F. Température max. du liquide pompé: 40 °C; pH: 6 – 10; densité max. 1100 kg/m³.

 Abwasser-Tauchpumpen für Schmutzwasser mit Festkörper und Faserstoffen.
Diese Pumpen sind aus hochwertigen Materialien hergestellt. 4 Pol Motor. Pumpengehäuse und Laufrad aus Grauguß. Einkanallaufgrad. Antriebswelle aus rostfreiem Stahl AISI 420. Ölgekühlte Doppel-Gleitringdichtung: aus Siliziumkarbid. 10 Meter Kabel H07RN8-F Dreiphasenspannung 400/690V. Motorvollschutz nach Benutzersorge. IP 68 Schutz. Isol. Klasse F. Max. Temperatur der Flüssigkeit: 40 °C; pH: 6 – 10; max. Dichte: 1100 kg/m³.

Modello Model Modèle Modell	Potenza Power Puissance Pferdestärke		Tensione Voltage Bobinage Spannung V-Hz-ph	A	Prevalenza - Head - Hauteur - Förderhöhe (m)						
	HP	kW			4	8	12	16	24	32	40
					Portata - Capacity - Débit - Fördermenge (l/min)						
VORTEX 1000	10	7,5	400/690-50-3	15,6/10,0	4500	3320	2150	900			
VORTEX 1500	15	11	400/690-50-3	23,4/14,0	5500	4070	2750	1425			
VORTEX 2000	20	15	400/690-50-3	31,8/18,5	6000	4700	3300	2000			
VORTEX 2700	27	20	400/690-50-3	39,7/22,9	7000	6000	4870	3720	1130		
VORTEX 3400	34	25	400/690-50-3	47,7/27,6	7200		6010	4950	2630		
VORTEX 4000	40	35	400/690-50-3	59,0/34,1	8500		7500	6350	4200	1900	
VORTEX 5500	55	40	400/690-50-3	73,1/42,2	8700		7750	5750	3750	1730	
VORTEX 6800	68	51	400/690-50-3	98,6/56,9	7700		5630	3380			

*On request other voltages are available

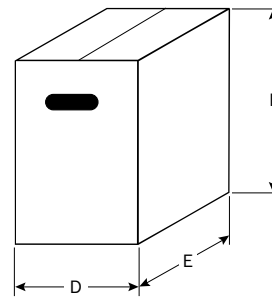
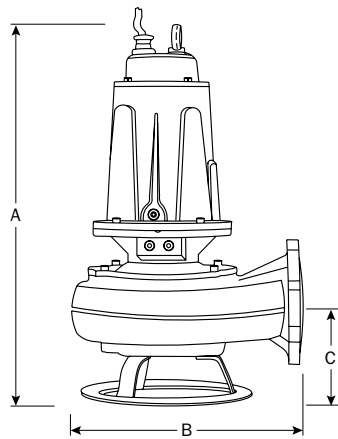
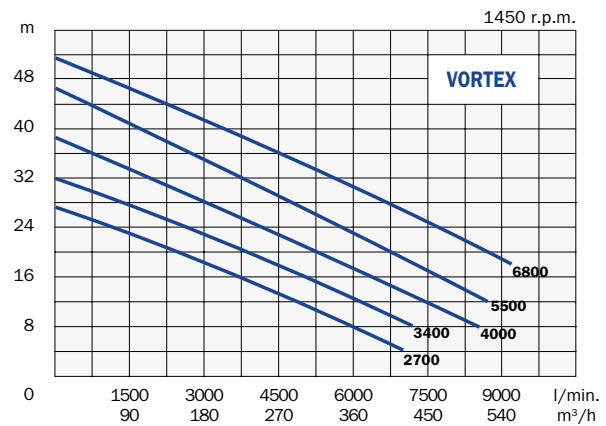
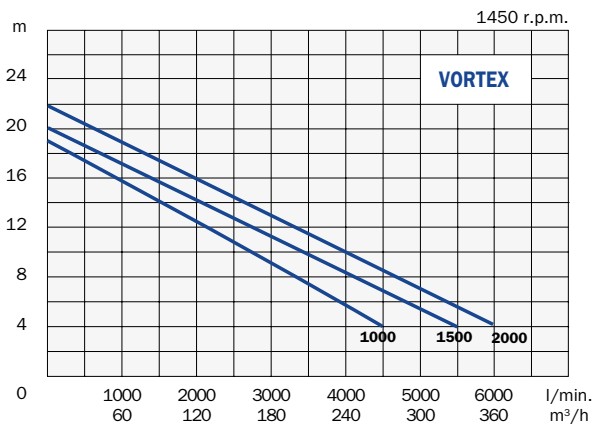

Modello Model Modèle Modell	Mandata Discharge Refoulement Druck-Seite	Corpi solidi Solid parts Corps solides Festkörper	Dimensioni - Dimensions - Masstabelle						Peso Weight Poids Gewicht
			mm						
			A	B	C	D	E	F	
VORTEX 1000	6" - DN 150 horizontal	100	720	528	267	540	430	640	122
VORTEX 1500	6" - DN 150 horizontal	110	956	641	325	670	570	950	260
VORTEX 2000	6" - DN 150 horizontal	110	956	641	325	670	570	950	272
VORTEX 2700	6" - DN 150 horizontal	120	997	641	325	670	570	950	308
VORTEX 3400	6" - DN 150 horizontal	120	997	641	325	670	570	950	320
VORTEX 4000	6" - DN 150 horizontal	120	1190	850	345	980	730	1310	550
VORTEX 5500	6" - DN 150 horizontal	120	1190	850	345	980	730	1310	585
VORTEX 6800	6" - DN 150 horizontal	130	1190	850	345	980	730	1310	600